

Top Mirror Welded Connector

We offer the unique possibility to provide selected liniLED® LED strips with a so-called 'mirror welded connector'. The mirror welded connector allows an immediate IP68 waterproof solution of the LED strip. The strip is pre-connected to the connector, so that it can be installed straight away.

All liniLED® Top and Side LED strips (incl. Diffuse) can be delivered with a mirror welded connector, with the exception of RGB and Tunable White LED strips.

In order to power liniLED® products safely, it is absolutely necessary to operate them with an electronically stabilized power supply protected against short circuits, overload and overheating.

To ease the luminaire/ installation approval, electronic control gear for liniLED® products should carry the CE mark. Preferably a controller from the liniLED® Control Range. In Europe, the declarations of conformity must include the following standards: CE: EN 55015, IEC 61547 and IEC 61000-3-2.

For the latest version of this datasheet, visit our website: www.liniLED.com







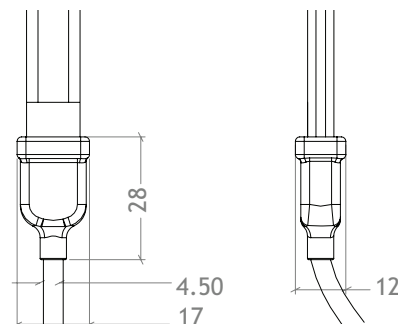



Product Characteristics

Dimensions	L31W15xH11 mm
Cord length	1 m, 5 m
Degree of protection	IP68
Colour	White
Material	PVC
Power Cord	White, PVC
Weight	1 m: 51 g 5 m: 175 g
Included	Mirror Welded End Cap

Product drawing



Symbols

-  Manufacturer's declaration that the product meets the applicable EC directives.
-  Restriction of Hazardous Substances (RoHS): product complies with the RoHS directive and each homogeneous material does not exceed the limits for the materials mentioned under the RoHS directive (Pb, Hg, Cd, Cr6+, PBB and PBDE).
-  Dust-tight, no ingress of dust. Protected against the effects of continuous immersion in water (Immersion in water at a maximum depth of 20 metres).
-  Product is resistant against ultraviolet (UV) light or sunlight. Non-UV resistant products can degrade or discolor fast when exposed to UV light.
-  Product can be cleaned with normal cleaning agents as specified in the datasheet under 'chemical compliances'.
-  This product can be stored and used below 0 degrees Celsius. Verify the minimum storage and operation temperature in the datasheet for the lowest temperature allowed.
-  This product can be applied in seawater and its environment. Elements in seawater will have no harmful effect on the product. For chemical specifications see datasheet. Verify the IP rating for proper use.
-  This product can be applied inside swimming pool environments. Elements in the air will have no harmful effect on the product. For chemical specifications of these elements see datasheet. Verify the IP rating for proper use.
-  This product is available on request and can be applied submerged in swimming pools and their environment. Disinfectants will have no harmful effect on the product. For chemical specifications of these elements see datasheet. Verify the IP rating for proper use.
-  System guarantee of 5 years when the complete system consist of liniLED® Products with the 5 year system warranty logo.

Disclaimer

The published information is checked to be as accurate as possible, however Triolight BV or any reseller of liniLED® cannot be held liable for any damages resulting from errors or outdated information. Triolight BV reserves the right to modify the information without informing the costumers. When this document is printed or downloaded, please check for the latest version on the internet, the most up to date information will be published on www.liniLED.com. This product should not be used in applications, devices or systems where incorrect operation of the product may result in personal injury (includes emergency lighting) without written permission from the board of Triolight BV. If nevertheless used in such applications, devices or systems Triolight BV cannot be held liable for any resulting injury.